

MALIBU II, BACK-OUTLET

Two-Piece Toilet, CEL

C-3240-C Bowl, T-3240 Tank

Product Features

- Vitreous china two-piece toilet, with skirted trapway
- Chair-height (16-1/2"), compact-elongated bowl
- MicroGlaze™ anti-microbial, stain-resistant glaze
- 4" (102mm) rough-in, back-outlet

High-Efficiency Flushing System

- High-performance, gravity flush
- 1.28 gallons (4.8 liters) per flush - EPA WaterSense, high-efficiency toilet (HET)
- 1000g MaP score
- Fully glazed, 2-1/8" internal trapway
- Oversized 3" flush valve
- Optimized rim jets, for an exceptionally clean bowl

Accessories Included

- Silent Close, quick-release seat and cover
- Solid metal trip lever, Polished Chrome finish
- Bolt alcove cover tiles (set of 2)

Quality Assurance

- Factory flush-tested
- Limited lifetime product warranty



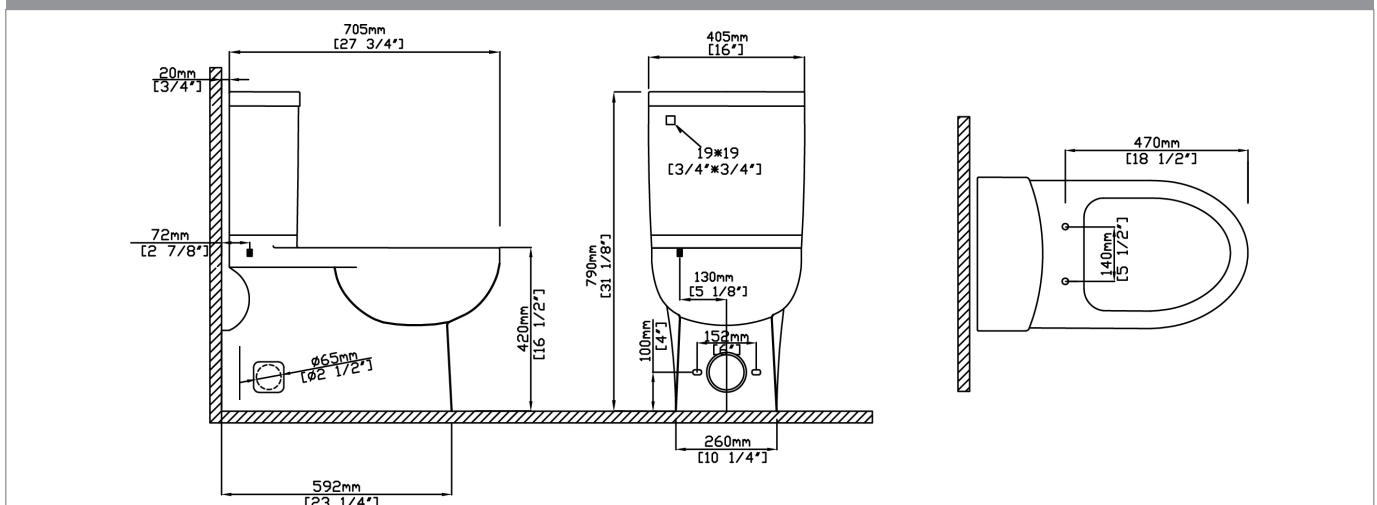

Dimensional Diagram







IMPORTANT: Dimensions are nominal and may vary within the range of tolerance per NSI Standard A112.19.2. These measurements are subject to change. No responsibility is assumed for use of superseded or voided pages.

PRODUCT OPTIONS & PARTS

Glaze Color Options		
 <p>White .01</p>		

Toilet Seat Options		
 <p>S-235 (Standard)</p>	<p>SB-242.500 Bolts SC-242 Caps</p> <ul style="list-style-type: none"> .500 Polished Chrome .502 Polished Nickel .503 Satin Nickel .504 Polished Brass .01 White (Plastic) .06 Balsa (Plastic) 	 <p>S-232 (Duroplast)</p>
		 <p>Seat Bolt Caps See toilet seat options at left, for matching bolt caps' model number and finish options.</p>

Tank Lever & Hardware Options			
 <p>F-62 (Standard)</p>	<ul style="list-style-type: none"> .500 Polished Chrome .502 Polished Nickel .503 Satin Nickel .504 Polished Brass .508 Venetian Bronze 	 <p>F-63</p>	
		<ul style="list-style-type: none"> .500 Polished Chrome .502 Polished Nickel .503 Satin Nickel .504 Polished Brass .508 Venetian Bronze .01 White Enamel 	
 <p>F-65</p>			
		<ul style="list-style-type: none"> .500 Polished Chrome .502 Polished Nickel .503 Satin Nickel .504 Polished Brass .508 Venetian Bronze .01 White Enamel 	
 <p>MC-300 (Standard)</p>	<ul style="list-style-type: none"> .01 White .06 Balsa 		

Metal Finish Options					
 <p>Polished Chrome .500</p>	 <p>Polished Nickel .502</p>	 <p>Satin Nickel .503</p>	 <p>Polished Brass .504</p>	 <p>Venetian Bronze .508</p>	 <p>White Enamel .01</p>

Replacement Parts				
Fill Valve	Flush Valve	Flapper	Tank-to-Bowl Kit	Floor Bolts
VL-5801	VH-5802.15	9400.580.01	9400.513.01	Not Included

Compliance Certifications	
<ul style="list-style-type: none"> • ASME A112.19.2M • CSA B45.1 	 <p>Meets the Americans With Disabilities Act (ADA) guidelines and ANSI A117.1 requirements for accessible building facilities. Check local codes.</p>