

### Features

- Two lever handles offer separate control of hot and cold water.
- 5-15/16" (151 mm) spout reach.
- 1.0 gpm (3.8 lpm) maximum flow rate at 60 psi (4.14 bar).
- KOHLER ceramic disc valves exceed industry longevity standards for a lifetime of durable performance.
- Clicker drain with tailpiece and overflow.
- Coordinates with other products in the Tone collection.

### Material

- Premium material construction for durability and reliability.
- KOHLER finishes resist corrosion and tarnishing.

### Installation

- For 8" - 16" (203 - 406 mm) centers.
- Deck-mount.
- Handles are preassembled on valves to simplify installation.

### Water Conservation & Rebates

- This product can help a building earn Water Efficiency points in LEED® Green Building Rating System.

### Recommended Products/Accessories

- K-23726 Drain treatment
- K-23723 Faucet cleaner

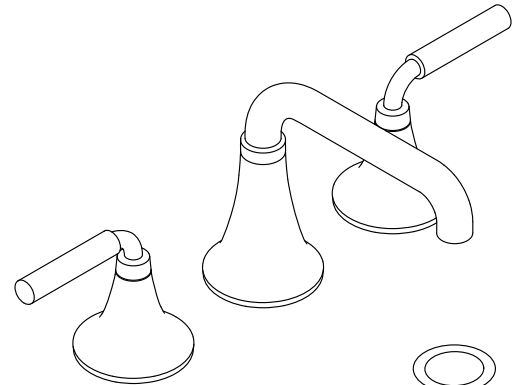

### Codes/Standards





ASME A112.18.1/CSA B125.1  
 NSF/ANSI 61  
 NSF/ANSI 372  
 All applicable US Federal and State material regulations  
 DOE - Energy Policy Act 1992  
 EPA WaterSense®  
 California Energy Commission (CEC)  
 ADA  
 ICC/ANSI A117.1  
 CSA B651  
 OBC

### KOHLER® Faucet Lifetime Limited Warranty

See website for detailed warranty information.

### Available Colors/Finishes

*Color tiles intended for reference only.*

Color	Code	Description
	CP	Polished Chrome
	BN	Vibrant® Brushed Nickel
	BL	Matte Black
	2MB	Vibrant® Brushed Moderne Brass
	BMB	Matte Black with Moderne Brass

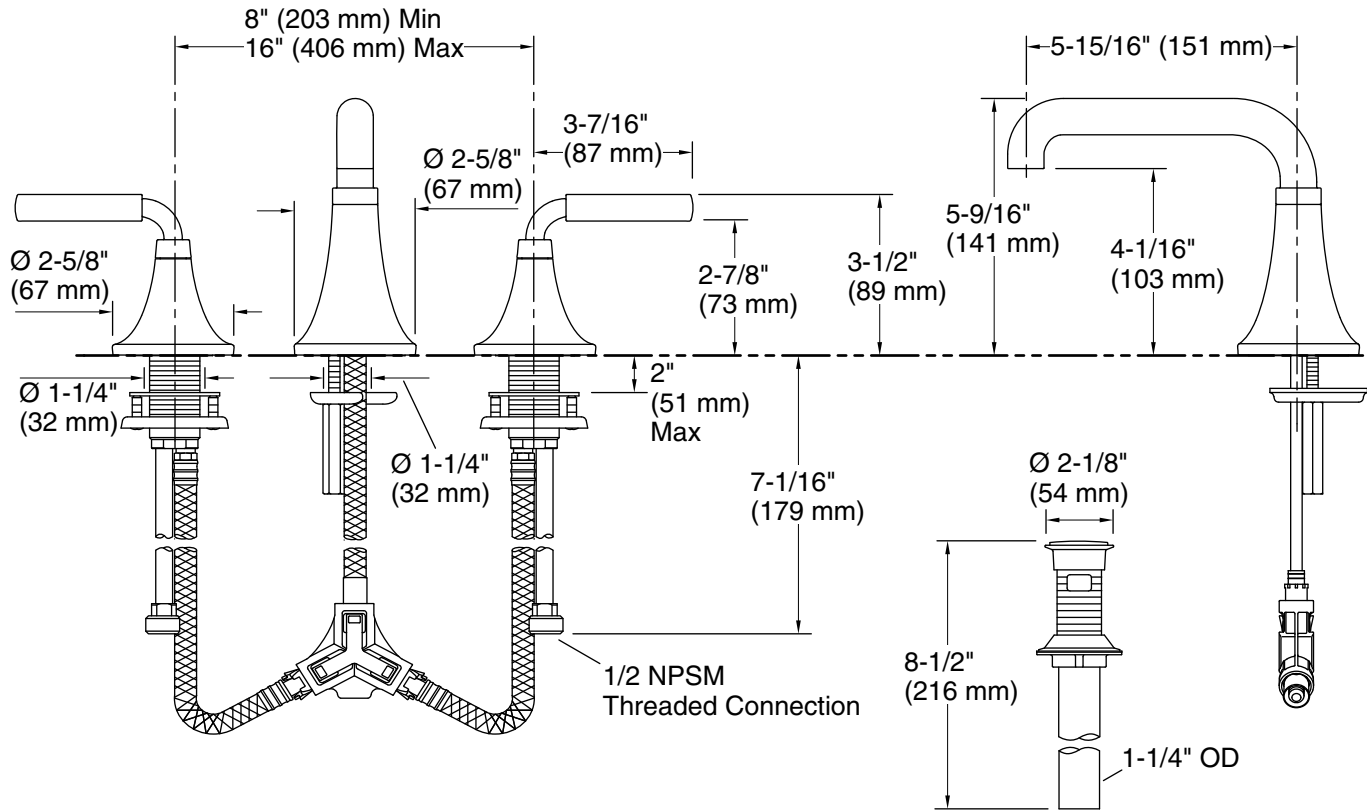

### Technical Information

All product dimensions are nominal.

#### Faucet:

Flow rate: 1 gal/min (3.8 l/min)

Pressure: 60 psi (4.1 bar)

Drain included: Yes

Drain with overflow: Yes

#### Spout:

Spout reach: 5-15/16" (151 mm)

### Notes

Install this product according to the installation instructions.

ADA, OBC, CSA B651 compliant when installed to the specific requirements of these regulations.