

34-WTR2-S1

Wall Mounted 2-Valve Shower Trim
For use with SS-506 concealed rough

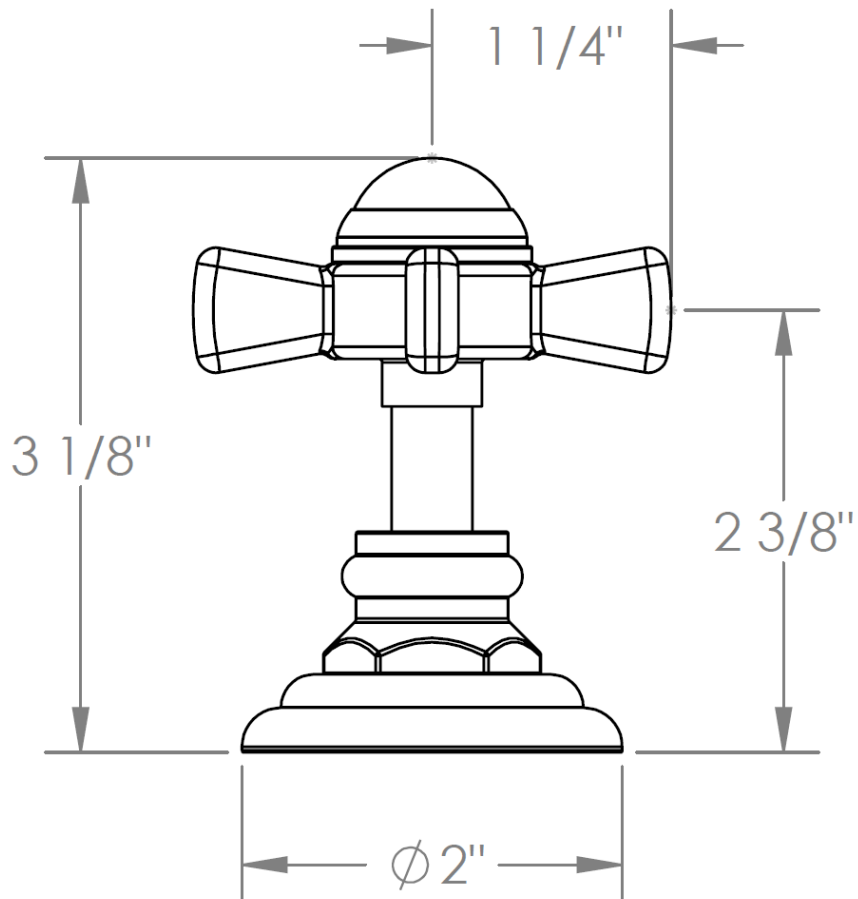

Meets the applicable requirements of ASME A112.18.1-2005/CSA B125.1-05, entitled "Plumbing Supply Fittings"

WATERMARK DESIGNS 9/4/2018

350 Dewitt Ave Brooklyn NY 11207 USA T 718 257 2800 F 718 257 2144 info@watermark-designs.com

Haley Handle Trim Options

B9M – SISTINA

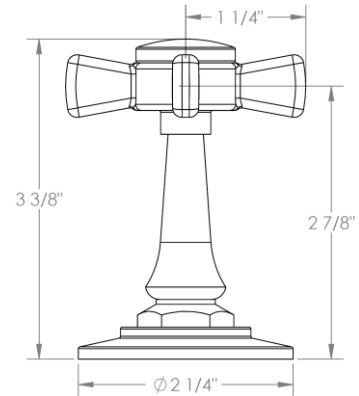

DD2 – ASTAIRE

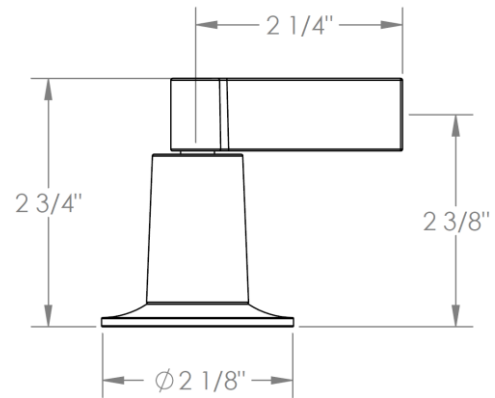

DD3 – GARBO

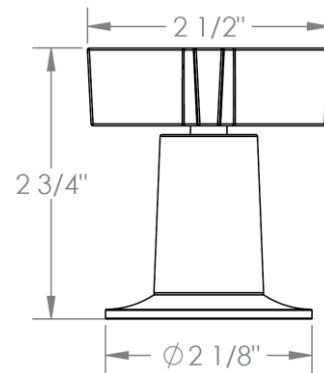

H4 – HARMONIE

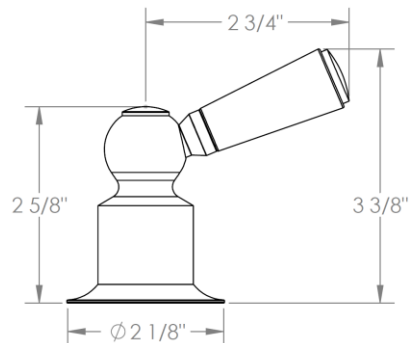

Haley Handle Trim Options

S1 – PRESTON

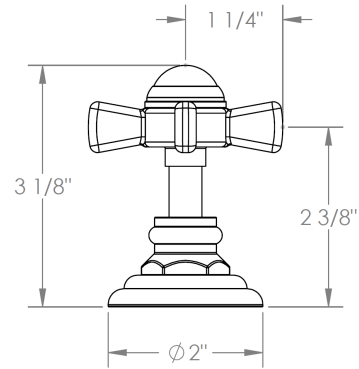

S1A – NOTTINGHAM

