

TRADITIONAL 18" APPLIANCE PULL

HTP-1800

• FITS MATERIALS FROM 1/4" TO 1-1/2" THICK

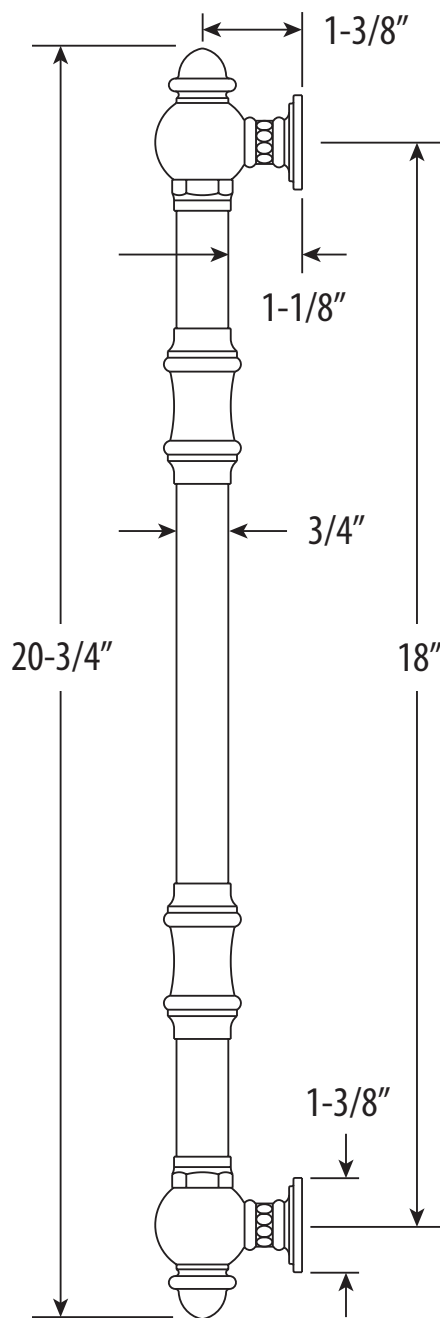

DIMENSIONS MAY VARY AND ARE SUBJECT TO CHANGE. NO RESPONSIBILITY IS ASSUMED FOR USE OF SUPERCEDED OR VOIDED DATA